



FX10 10" SUBMERSIBLE PUMPS

The FX10 pump is a mixed-flow cast iron pump with a new design for easy maintenance.

Applications

Domestic and industrial water supply.
Aqueducts.
Fire-fighting systems.
pressurising water system.
Shower and running irrigation .
Several plants.

Materials

G25 cast iron for top, bottom ,impeller and diffuser.
(availability for bronze impeller and bowl)
AISI 420 stainless steel for shaft.
AISI 430F stainless steel for coupling.
AISI 316 with hard chrome cover for top
and bottom bushes.
Rubber for wear ring
AISI 304 stainless steel for screen and cable guard

Operating data

capacity up to 390 m³/h
head up to 260m power up to 150kW
max.water temperature 30°C
max.sand content:40: g/m³
direction of rotation: CCW facing delivery side
min.recommended head of water above
pump suction :1m

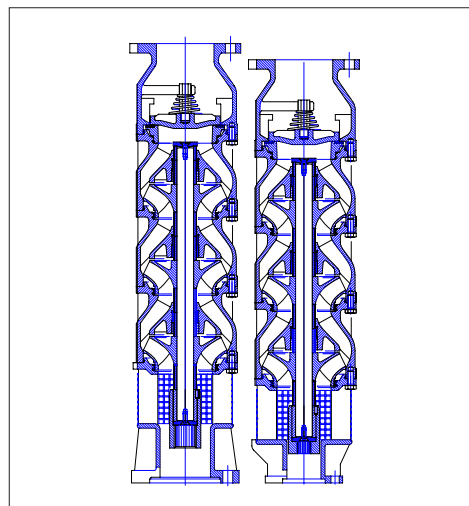

SECTIONAL VIEW

FX10 10"





FX10 performance chart

50 Hz 2 poles		Q (mc/h)	0	90	102	114	126	138	150	162	180	210	240	270	300	330	360	390		
TYPE	HP	Q (l/min)	0	1500	1700	1900	2100	2300	2500	2700	3000	3500	4000	4500	5000	5500	6000	6500		
FX10-160/1	20	H (m)	37	29	28	27	26	25	23	22	19	13								
FX10-160/2	40		75	58	56	53	52	49	46	43	38	27								
FX10-160/3	60		112	87	84	80	78	74	69	65	57	40								
FX10-160/4	75		149	116	111	107	103	98	93	87	76	53								
FX10-160/5	90		187	145	139	134	129	123	116	109	95	66								
FX10-160/6	110		224	174	167	160	155	147	139	130	114	80								
FX10-200/1	25		43		35	33	32	31	30	29	27	23	18							
FX10-200/2	50		87		69	67	65	62	60	58	53	46	36							
FX10-200/3	75		130		104	100	97	93	90	87	80	69	54							
FX10-200/4	100		174		139	134	130	125	120	115	107	92	71							
FX10-200/5	125		217		174	167	162	156	150	144	134	115	89							
FX10-200/6	150		260		208	201	195	187	180	173	160	138	107							
FX10-240/1	30		41					32	31	30	29	27	24	21	16	12				
FX10-240/2	60		81					63	61	59	57	53	48	42	33	23				
FX10-240/3	90		122					94	91	89	86	80	72	63	49	35				
FX10-240/4	125		162					125	122	119	114	107	97	83	65	46				
FX10-240/5	150		203					156	152	149	143	134	121	104	81	58				
FX10-240/6	200		243					188	183	178	171	160	145	125	98	69				
FX10-280/1	40		42							34	33	32	30	28	26	23	19	14		
FX10-280/2	80		84							67	66	63	60	56	51	45	38	27		
FX10-280/3	125	126							101	99	95	90	84	77	68	57	41			
FX10-280/4	175	168							134	132	126	120	111	103	90	76	54			
FX10-280/5	200	211							168	165	158	150	139	129	113	95	68			

FX10-160 pump type

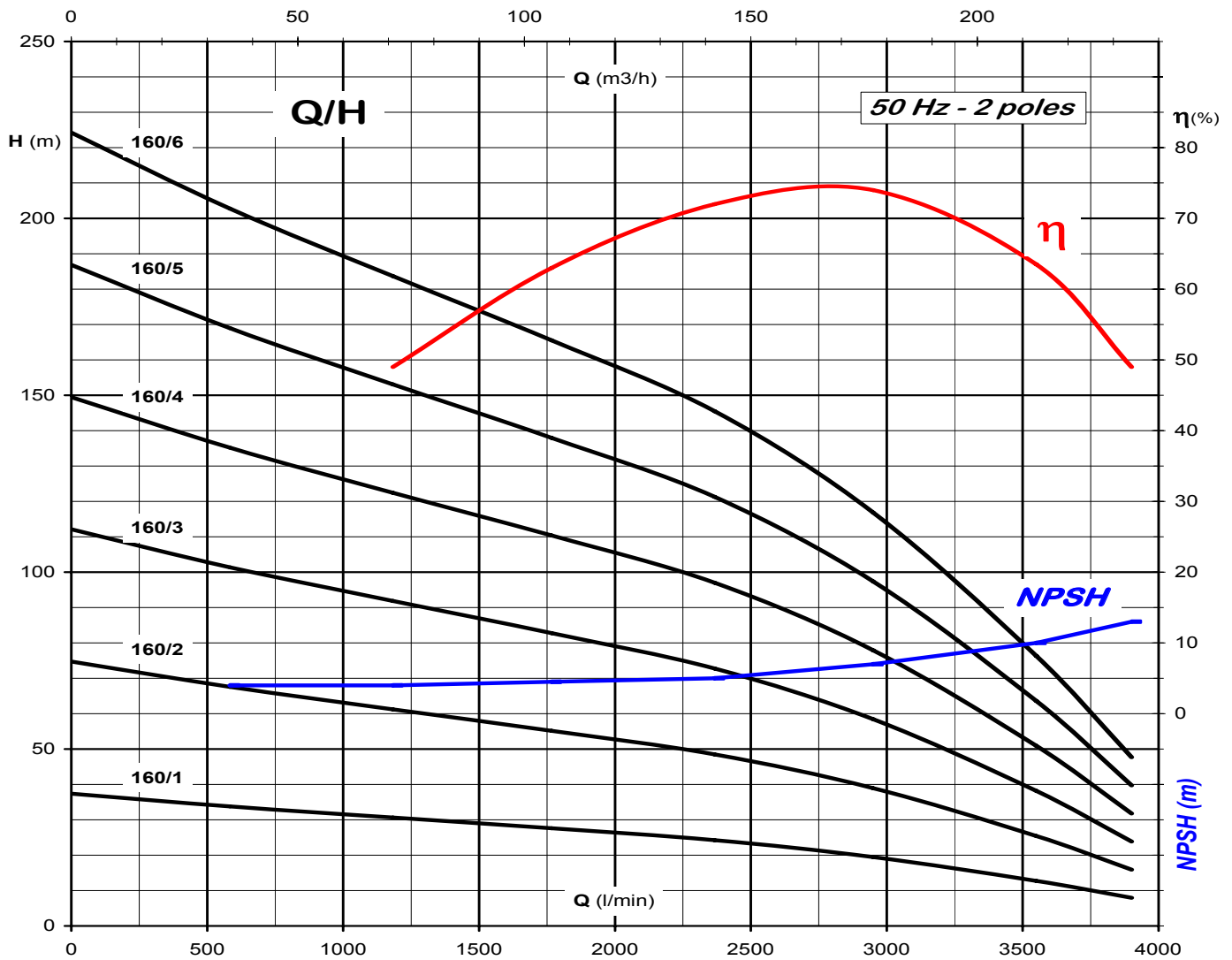

DIMENSIONS AND WEIGHTS					
TYPE	motor type	HP	kW	L	W
				mm	Kg
FX10-160/1	8" *	20	15	870	92
FX10-160/2	8" *	40	30	1040	114
FX10-160/3	8" *	60	45	1210	136
FX10-160/4	8" *	70	52	1380	158
FX10-160/5	8" *	90	67	1550	180
FX10-160/6	8" *	110	82	1720	202

* = NEMA COUPLING

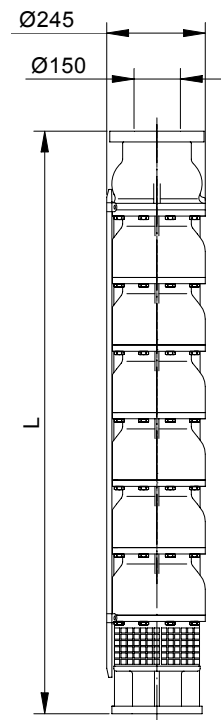

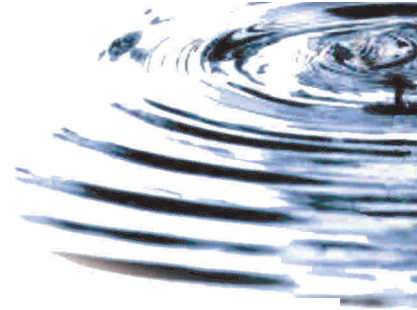

FX10-200 pump type

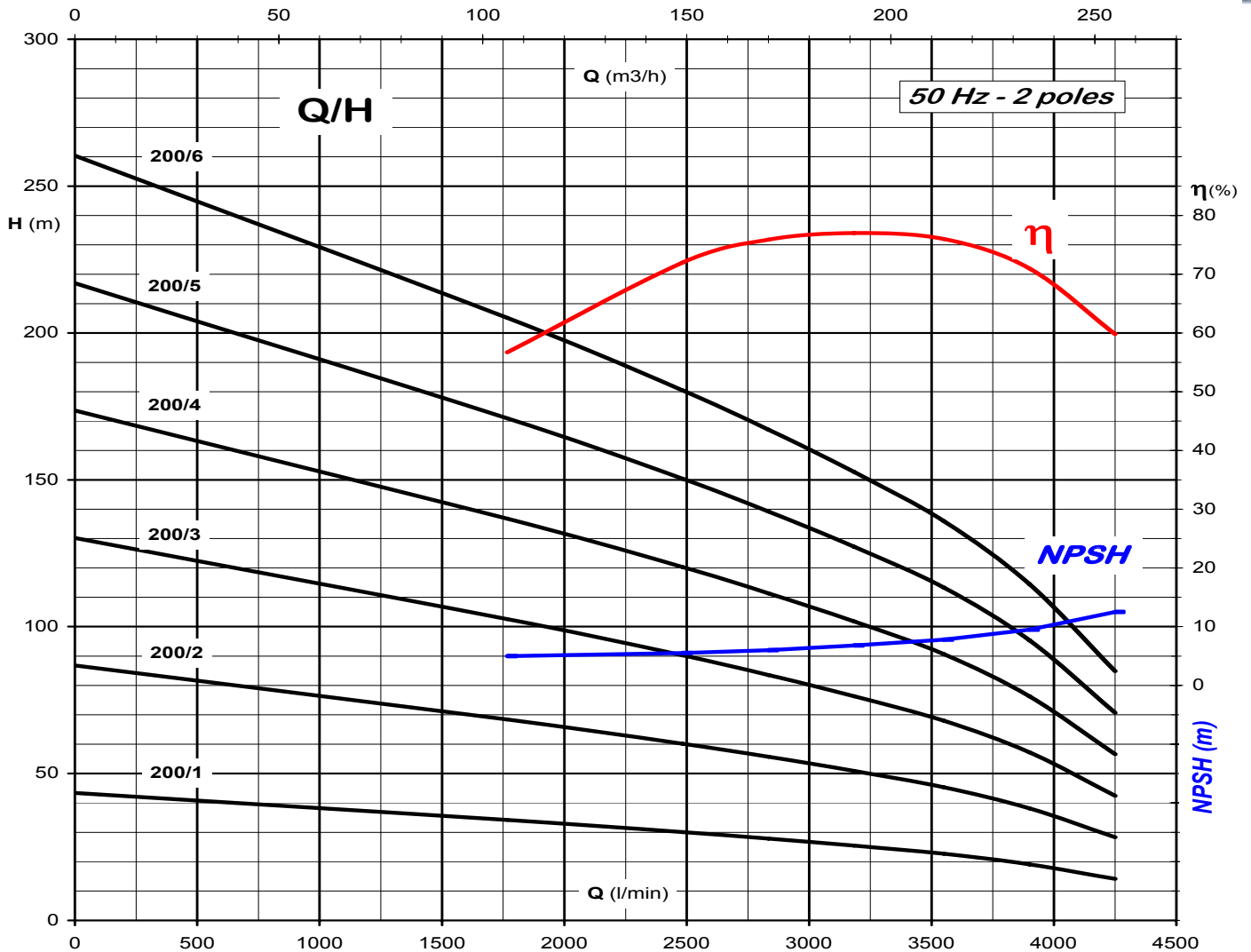

DIMENSIONS AND WEIGHTS					
TYPE	motor type	HP	kW	L	W
				mm	Kg
FX10-200/1	8" *	25	18,5	870	92
FX10-200/2	8" *	50	37	1040	114
FX10-200/3	8" *	75	56	1210	136
FX10-200/4	8" *	100	75	1380	158
FX10-200/5	8" *	125	93	1550	180
FX10-200/6	8" *	150	110	1720	202

* = NEMA COUPLING

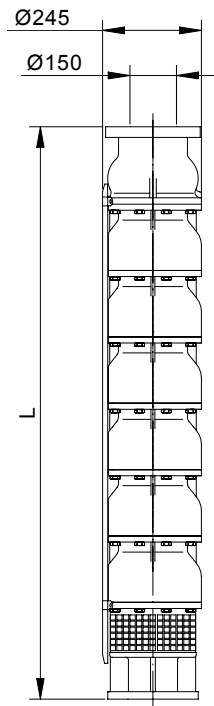



FX10-240 pump type

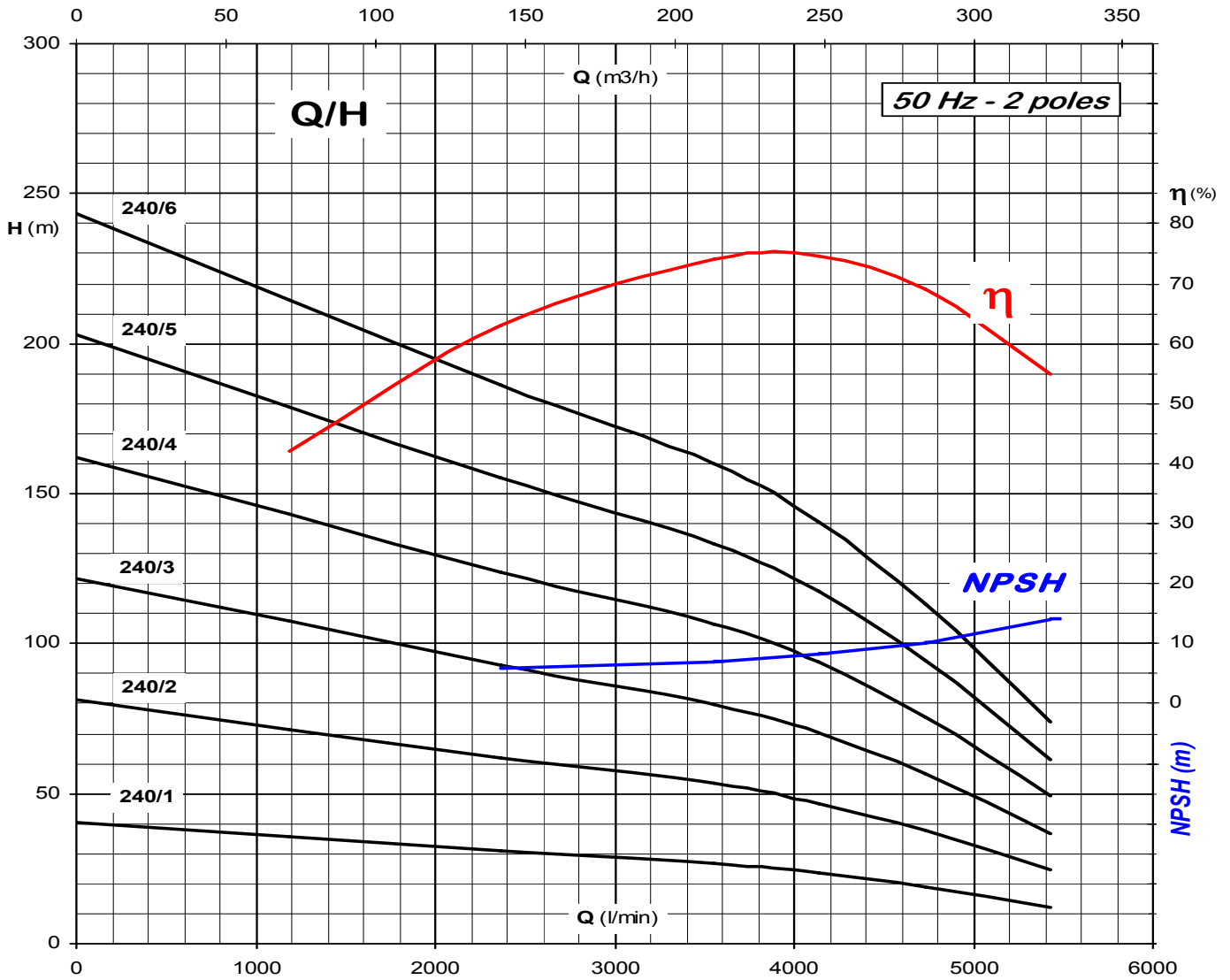

DIMENSIONS AND WEIGHTS					
TYPE	motor type	HP	kW	L	W
				mm	Kg
FX10-240/1	8" *	35	26	870	92
FX10-240/2	8" *	70	52	1040	114
FX10-240/3	8" *	100	75	1210	136
FX10-240/4	8" *	125	93	1380	158
FX10-240/5	8" *	175	130	1550	180
FX10-240/6	8" *	200	150	1720	202

* = NEMA COUPLING

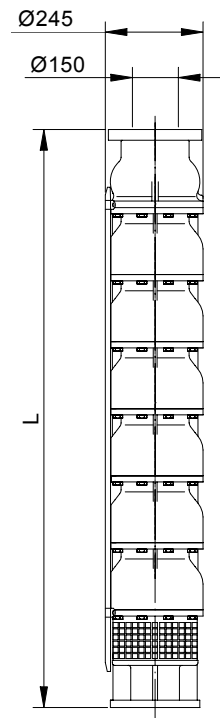



FX10-280 pump type

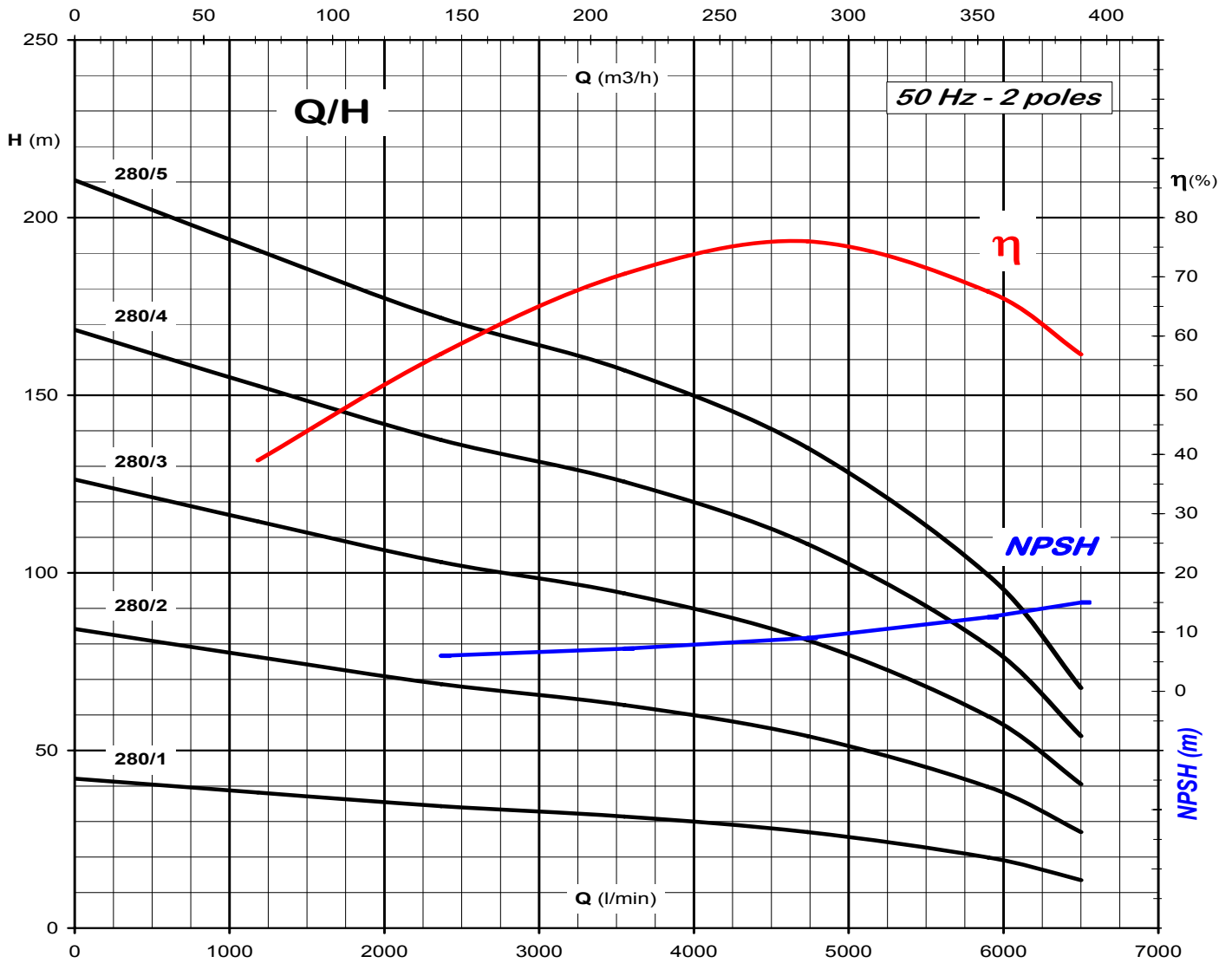

DIMENSIONS AND WEIGHTS					
TYPE	motor type	HP	kW	L	W
				mm	Kg
FX10-280/1	8" *	40	30	870	92
FX10-280/2	8" *	80	60	1040	114
FX10-280/3	8" *	125	93	1210	136
FX10-280/4	8" *	175	130	1380	158
FX10-280/5	8" *	200	150	1550	180

* = NEMA COUPLING

